

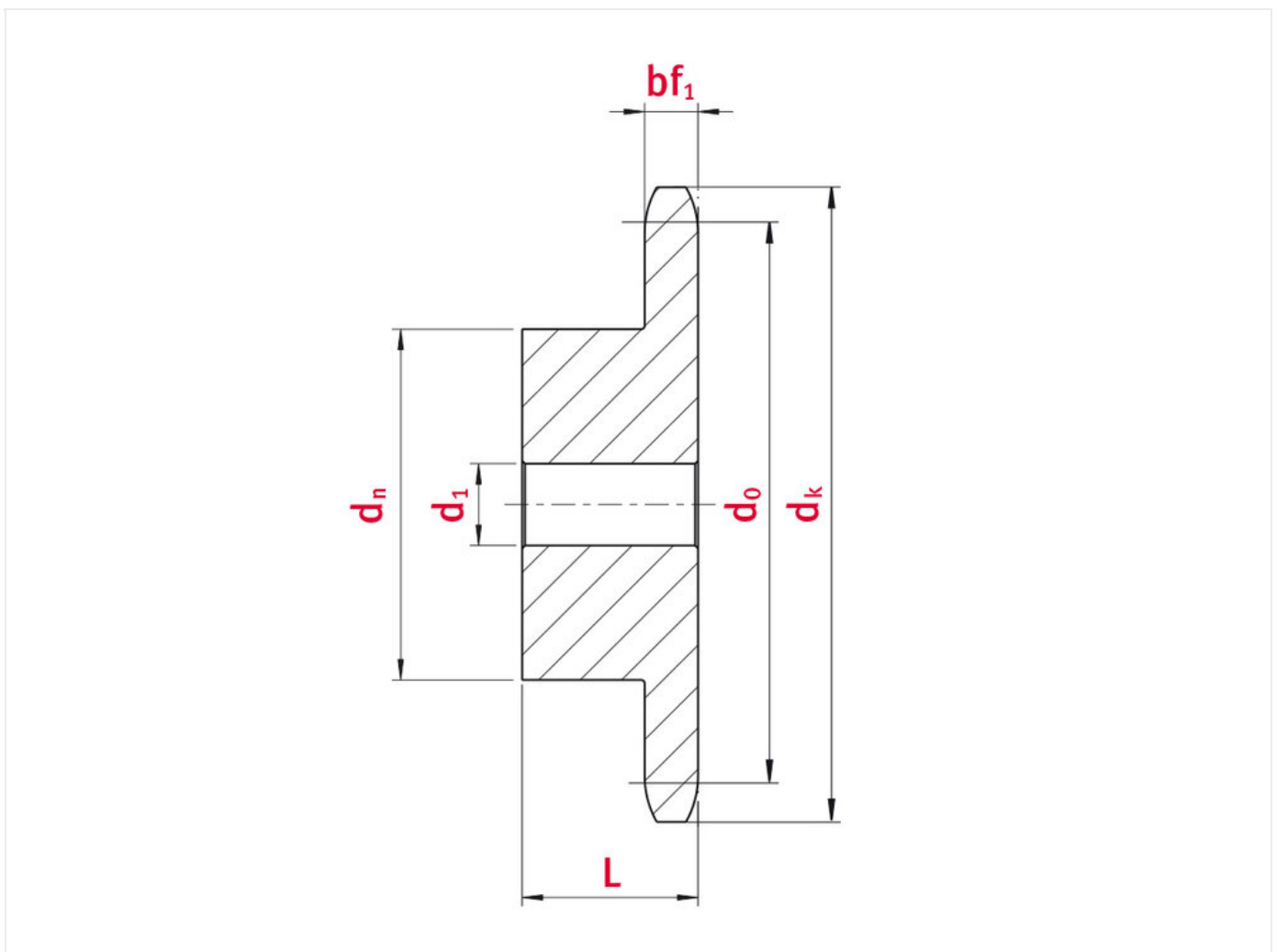

sprocket 12B-1 8 teeth

Part no.: 81006235
Packaging Unit: 1pce

Model: 8 teeth



Technical data

SPROCKET	12B
Pitch p (mm)	19,05
Width between inner plates b1 min. (mm)	11,68
Roller diameter d1 max. (mm)	12,07

Teeth	8
Tooth width simplex bf1 (mm)	11,1
Tip circle dk (mm)	57,6
Pilot bore d1 (mm)	12
Total length L (mm)	30
Hub	31

Product Information

iwis offers in the "plate wheels and drive components" sector an impressively wide range and broad stock of various plate wheels with pilot bores, and has full machining facilities in order to rapidly rework pilot bore plate wheels to customers demands. Furthermore, iwis provides fully finished plate wheels manufactured according to customer designs and drawings. iwis can always supply a wide range of ISO 606-compliant standard sprockets and plate wheels from stock. Our standard range covers sprockets and plate wheels in sizes 05 B-1 to 32 B-3.

Highlights:

- All sprockets are suitable for roller chains based on the requirements of ISO 606
- All sprockets with pilot bores
- The material used is unalloyed tempered steel
- Special surface treatments are available on request



REQUEST DIRECTLY ONLINE NOW

<https://www.iwis.com/en-en/products-services/sprocket-12b-1-8-teeth~p5731>

Useful information



CALCULATION PROGRAM

InduKet: the Chain Drive
Calculation Program for
Engineers.

iwis.com/chaincalc



CHAIN CALCULATION

The right drive solution for your
challenge.

chaindrive@iwis.com