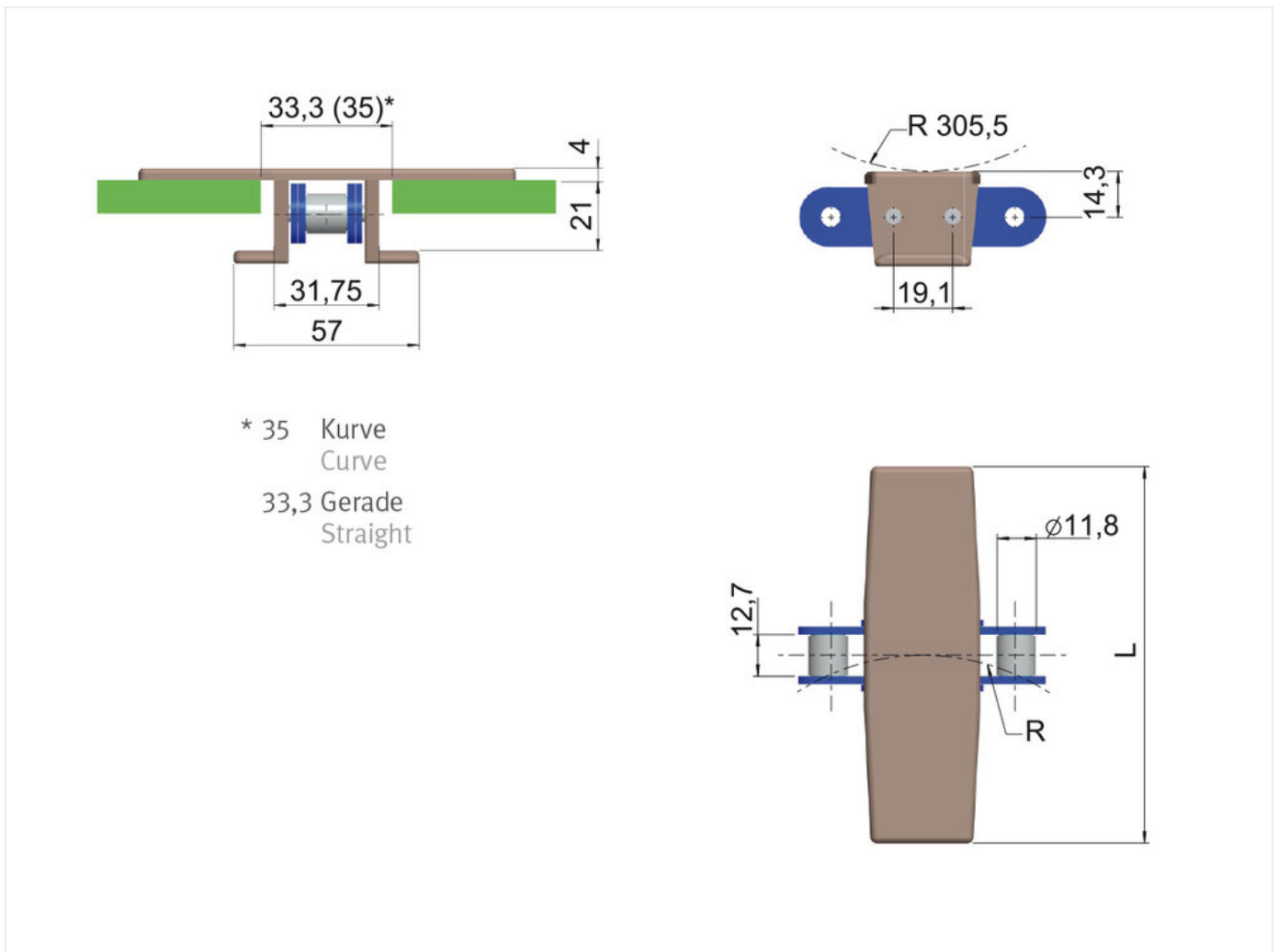

Plate Top Chain 1873 Series 1873, hardened carbon steel - FLEXON

Part no.: 34387
Packaging Unit: 3,048m

Brand: FLEXON
Model: Series 1873
Surface: hardened carbon steel



Technical data

FLAT TOP CHAIN	1873
Weight per meter (kg)	2,41
Back flex radius (mm)	305
Width L (mm)	152,4

Average breaking load (N)	27
Minimum Curve radius R (mm)	457
Snap on material	LF
Material base chain	C45
Pitch base chain (mm)	19,05

Product Information

The FLEXON range of Plate Top chains are two piece assemblies of base roller chain, in steel or stainless steel, onto which a plastic plate is mounted. The combination of the two elements creates a chain with high breaking load provided by the ELITE base chain plus the benefit of a very flat top surface.

Top plates ready assembled on carbon steel base chain.

Highlights:

- ANSI 60 side bow base chain with extended pins
- Easy to change out the snapped on top plates

Applications

- Feeding and automation technology

REQUEST DIRECTLY ONLINE NOW

<https://www.iwis.com/en-en/products-services/plate-top-chain-1873-series-1873-hardened-carbon-steel-flexon~p7267>

Useful information



CALCULATION PROGRAM

InduKet: the Chain Drive
Calculation Program for
Engineers.

iwis.com/chaincalc



CHAIN CALCULATION

The right drive solution for your
challenge.

chaindrive@iwis.com